

Room Divider/Cubicle/ Shower Rail Systems

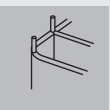



Room Divider/Cubicle/Shower Rail System

Silent Gliss® 6100

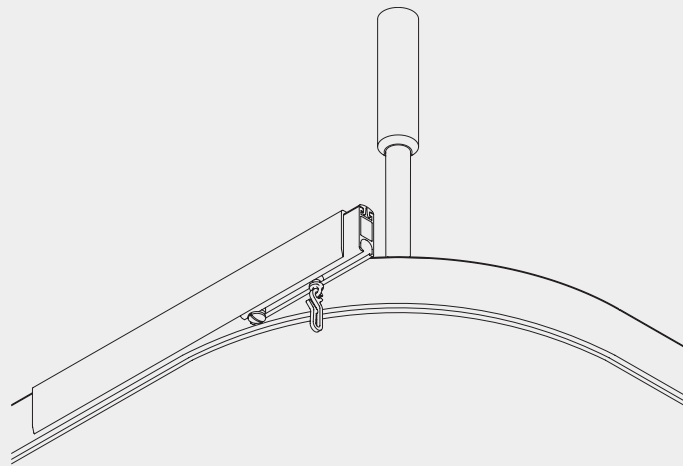

Product Information

- For over 40 years the most widely used hospital cubicle system in the world
- Also used for many varied industrial and commercial applications
- Attractive profile combines mechanical strength and flexibility with the smoothest performance
- The design detail gives rigidity and strength with great flexibility in layout whilst achieving a clean unbroken line in hospital wards
- The top channel maximises connection positions and suspension variations. The dust cover strip reduces the risk of cross infection
- Quick release safety device is available through distributors for high risk areas, (see System 6650)
- Stand colour silver. Also available in white
- Standard lengths 6101 in metres: 4.5m, 4.75m, 5.0m, 5.25m, 5.5m, 6.0m, 6.75m, 7.5m (silver only). Profile connector available
- For medium to heavy curtains
- An exclusive network of skilled distributors measure, supply and fix all hospital contracts in the U.K. and Eire
- Conforms to HTM66
- White profile incorporates BioCote anti-microbial coating as standard



6100

Profile, Bending and Specification Information

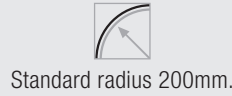
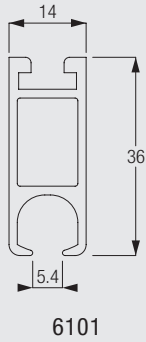

The standard radius is recommended for optimal operation. The minimum possible radius is 150mm.

6109 An alternative profile to be used for reversible shower rails or uprighter systems (available through distributors).

Specification Guide - download from www.silentgliss.co.uk (password required).

Silent Gliss 6100 cubicle track system, anodised aluminium rail type 6101, secured to fittings detailed below by approved local distributor. Allow for noggins in suspended ceiling/hollow partitions elsewhere in B of Q.

Pre-forming bend in running length 90/135 degrees.

Dust cover 6110 fitted to track.

Nylon glider/hook 6147 fitted to track at 10/metre.

Delrin wall support 6609 twice screwed/plugged to wall and fitted to track.

Wall bracket 6503/anodised aluminium 50mm wide (two per set), each bracket screwed/plugged to wall and fitted to track.

Delrin end cover 6611 secured to track.

End stop 6007 secured to track.

Connecting bridge 6512, anodised aluminium secured to track.

T-junction 6514, anodised aluminium secured to track.

Double T-junction 6525, anodised aluminium secured to track.

Internal connecting bridge secured to track.

Ceiling fixing plate 6137, anodised aluminium (single), once screwed through ceiling to noggin above (noggin by others)/plugged and screwed and secured to track.

Double ceiling fixing plate 6138, anodised aluminium twice screwed through ceiling to noggin above (noggin by others)/plugged and screwed and secured to track.

6190 Hanger, anodised aluminium assembly drop m once screwed through ceiling to noggin above (noggin by others)/plugged and screwed and secured to track.

6501 V-hanger, anodised aluminium assembly drop m twice screwed through ceiling noggins (noggins by others)/plugged and screwed and secured to track.



6100

System Layout Options

As a universal room divider system with various accessories, there are few limits to size and layouts. The recommended height from floor level to the underside of the track is 2100mm.

Typical layout for hospital (without V-hangers)

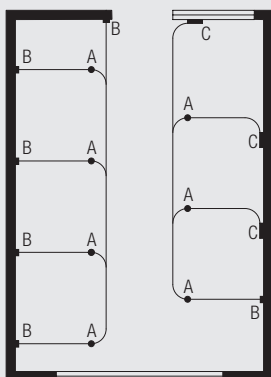

A: hanger rod 6190
B: wall support 6609
C: bracket 6503

Typical layout for hospital (with use of V-hangers)

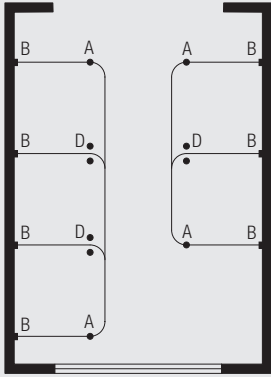

A: hanger rod 6190
 B: wall support 6609
 D: V-hanger 6501

Lateral stability in any cubicle layout is essential to prevent weakening of the wall and ceiling fixtures by lateral movement. Where it is not practical to fit tie bars etc., stability may be obtained by the incorporation of V hangers to the ceiling as shown in the diagram above.

Fitting Information

The System 6100 is normally ceiling and wall fixed on suspended hangers and special wall brackets.

Site preparation for suspended ceiling applications

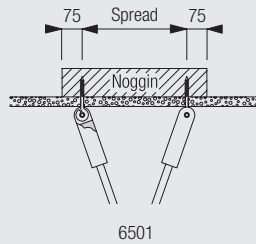
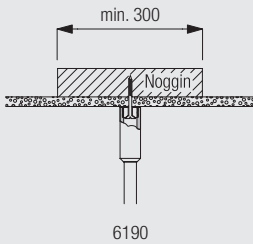

Fixings should support the ends of the profile and any changes in direction. Maximum span between fixings is 3000mm. When fitting to suspended ceilings site preparation is critical. At each hanger position a noggin in approved material is required above the suspended ceiling; underside to rest on top of ceiling (but independently supported) with a minimum length of 300mm at right angles to the track in which the hanger occurs to give fixing tolerance. Ideally the hangers should be on the return track, if on the front track then adequate support should be provided. A detailed information sheet is available on request.



6100

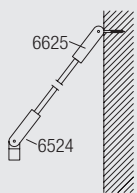

Diagonal fixing supports can be used to return the hanger to the bedhead wall, but only for use when it is impossible to ceiling fix.

Dust Cover Strip

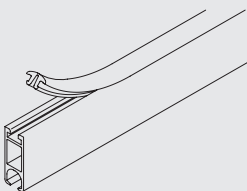

Dust cover strip 6110 for profile 6101 (6108 for profile 6109), it reduces the risk of cross infection.

Fitting Options

Ceiling fix with fixing plates

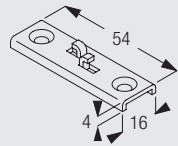
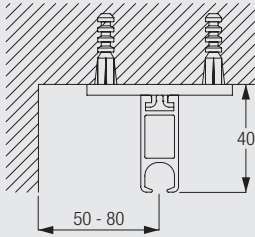

6124
Twist fixing plate



6137
Ceiling fix bracket



6138
Ceiling fix bracket
double (42mm)

Fixing plate positioning is recommended at maximum 300mm intervals.

Ceiling fix with ceiling support 6175

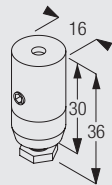
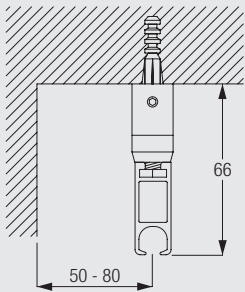

6175
Ceiling support

Bracket positioning is recommended at maximum 300mm intervals.

Ceiling fix with hanger rod 6190



6100

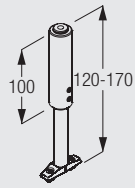
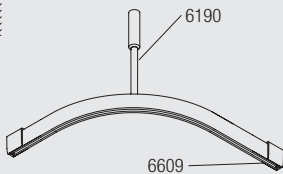
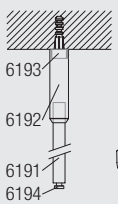

6190
Hanger rod assembly

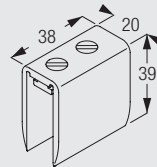

6609
Wall support

Can also be fixed through suspended ceilings by using special sleeves 6197, 6187, 6188

Ceiling fix with V-hanger 6501

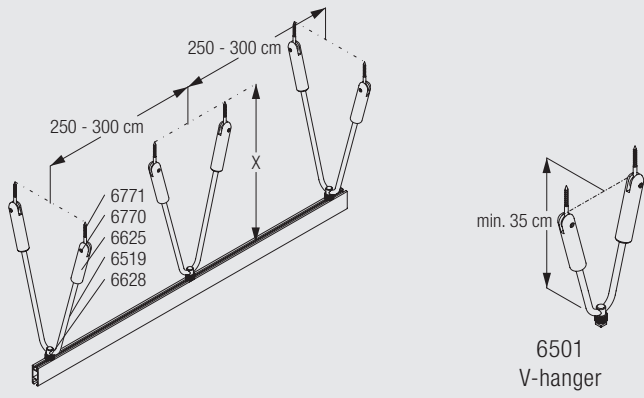

Lateral stability in any cubicle layout is essential to prevent weakening of the wall and ceiling fixtures by lateral movement. V-hangers (25°-35°) provide alternative lateral stability when not practical to fit tie bars and to stabilise straight track over 3 metres.

Wall fix at 90° to wall

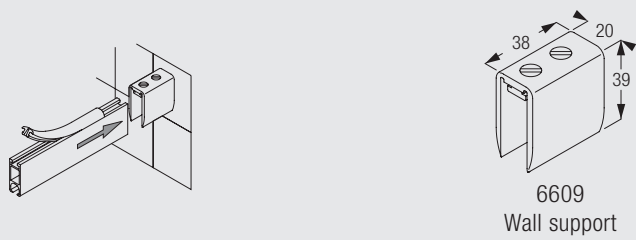

Profile Junctions (join lengths at 90°)

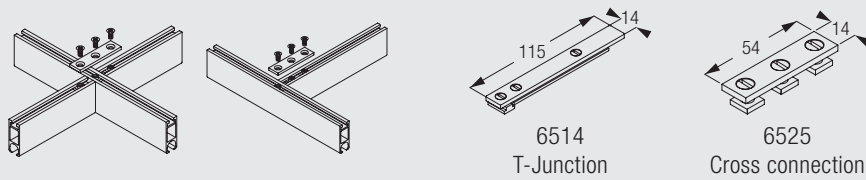

Profile Connecting bridge 6512 (bent applications)

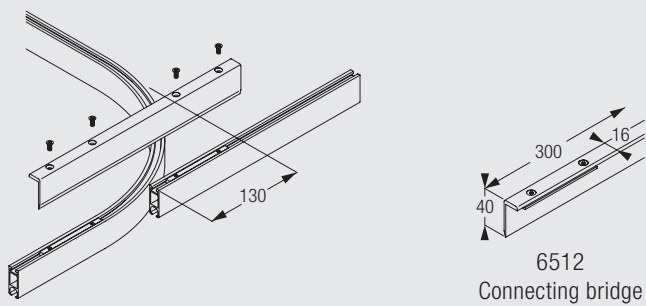

Wall fix with bracket 6503(a-g)

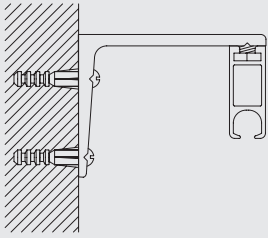

	(mm)		(mm)
6503a	50x50	6503b	200x50
6503c	50x100	6503d	100x50
6503e	25x50	6503f	100x100
6503g	75x150		

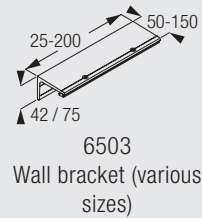

Standard Accessories

6007 Endstop



6065 Twist eye endstop



6083 Glider



6086 Spring stop



6094 Roller glider with hook



6096 Glider 6083 in strip form



6098 Roller glider with eye



6101 Profile



6110 Dust cover



6124 Twist fixing plate



6137 Ceiling fix bracket



6138 Ceiling fix bracket double (42mm)

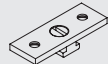

6143 Glider 6144 in strip form



6146 Hook



6147 Glider 6144 with hook 6146 in strip form



6175 Ceiling support



6187 Dummy ceiling support sleeve



6199 Internal connecting bridge

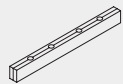

6503 Wall bracket (various sizes)

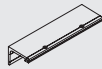

6512 Connecting bridge



6514 T-Junction

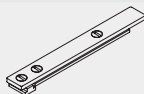

6525 Cross connection

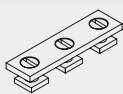

6609 Wall support



6611 Endcover



6628 V-hanger track insert



Sets

6190 Hanger rod assembly

6194 Track insert

1









6100

	6191	Hanger rod	1	
	6192	Sleeve	1	
	6193	Ceiling stud	1	
6501	V-hanger assembly			
	6771	Vine eye	1	
	6770	Locking pin	1	
	6625	Complete fixing sleeve	1	
	6519	Hanger rod	1	
	6628	V-hanger track insert	1	

Optional Accessories

Parts

6108	Dustcover for 6109		6109	Profile	
6160	Connecting piece		6188	Ceiling support	
6197	Hanger joint sleeve		6283	Roller glider	
6524	Diagonal fixing support				

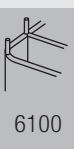

Useful Information

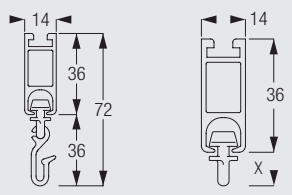

The left hand diagram illustrates the standard measurements for 6100 cubicle/shower system with combined 6147 glider/hook. For non medical application refer to the right hand illustration and the figures below for the roller/glider dimensions.

- 6083 = 7mm
- 6094 = 31mm
- 6098 = 26mm
- 6283 = 7mm
- 6144 = 9mm



6100



6100

www.silentgliss.co.uk

www.silentglissglobal.com

Silent Gliss Ltd
Pyramid Business Park
Poorhole Lane
Broadstairs
Kent
CT10 2PT
Great Britain

Tel: +44 (0) 1843 863571
Fax: +44 (0) 1843 864503
info@silentgliss.co.uk

Silent Gliss Global Ltd
Pyramid Business Park
Poorhole Lane
Broadstairs
Kent
CT10 2PT
Great Britain

Tel: +44 (0) 1843 874250
Fax: +44 (0) 1843 874457
info@silentglissglobal.com